

now with
Windows NT



Vector Network Analyzer Family ZVR

4 models for all requirements: ZVRE, ZVCE, ZVR, ZVC

- Excellent dynamic range
>130 dB
(measurement bandwidth 10 Hz)
- Low inherent noise
<-130 dBm
(measurement bandwidth 10 Hz)
- Broad frequency range for universal use
10 Hz to 4 GHz (ZVRE, ZVR)
20 kHz to 8 GHz (ZVCE, ZVC)
- High measurement speed
<125 μ s/point (normalized)
<240 μ s/point (fully calibrated)
- Fast data transfer via IEC/IEEE bus
Transfer time <15 ms (200 points)
- Customized models for special applications
Modular configuration using options
- High sweep rate
>>25 sweeps/s (200 points)
- Manual calibration techniques
TOM, TRM, TRL, TNA, TOSM, TOM-X
- Automatic calibration
AutoKal
- Compatibility with PC, CAE
Internal PC with WindowsNT operating system suitable for PC applications



ROHDE & SCHWARZ

Innovation in terms of versatility, speed and accuracy

A family for every requirement

The vector network analyzers of the ZVR family from Rohde&Schwarz set new standards regarding versatility, speed and accuracy.

The family comprises the four Vector Network Analyzers ZVRE and ZVR as well as ZVCE and ZVC which extend the frequency range to 8 GHz. All models are compact instruments with integrated generator, test set and receiver, each tailored to a specific field of application.

Thanks to the great variety of options and test sets, the analyzers can be tailored even to very special kinds of measurement tasks.

300 kHz..... 4 GHz

ZVR, ZVRE (active bridges)

9 kHz 4 GHz

ZVR, ZVRE (passive bridges)

10 Hz 4 GHz

ZVR, ZVRE (with Ext. Measurements option)

20 kHz 8 GHz

ZVC, ZVCE (active couplers)

20 kHz 8 GHz

ZVC, ZVCE (passive bridges)

300 kHz 8 GHz

ZVC, ZVCE (active bridges)

Wide frequency range..... 10 Hz to 4 GHz or 20 kHz to 8 GHz

High measurement speed..... <125 μ s per point

Wide dynamic range..... >130 dB (measurement bandwidth 10 Hz)

Innovative calibration methods.....AutoKal, TOM, TRM, TRL, TNA, TOM-X

Short IEC/IEEE-bus response times.....Read-out time <15 ms (200 test points)

In contrast to passive SWR bridges/couplers active SWR bridges/couplers contain a bias network, e.g. for supplying amplifiers.

Design

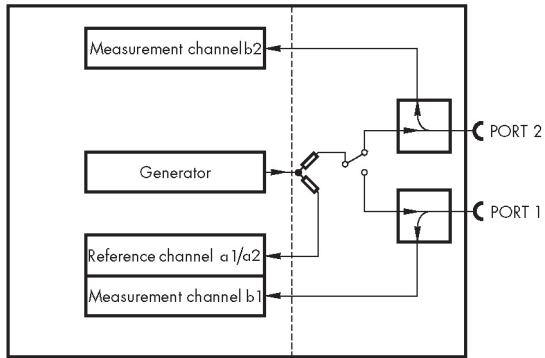

ZVRE, ZVCE (bidirectional, 3 channels)

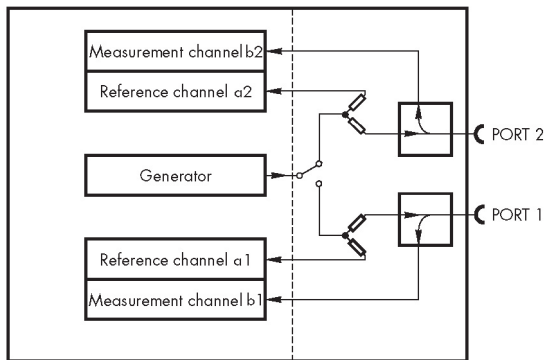

ZVR, ZVC (bidirectional, 4 channels)

With a **bidirectional** analyzer all four S-parameters of the DUT can be determined without changing connections.

The 4-channel analyzers provide the calibration methods TOM, TRM, TRL, TNA and TOM-X.

Comparison of four models

The highlights in brief

Model	ZVRE	ZVR	ZVCE	ZVC
Test set	bidirectional			
Receiver channels	3	4	3	4
Wide frequency range	10 Hz ¹⁾ to 4 GHz		20 kHz to 8 GHz	
Wide dynamic range ¹⁾	>125 dB	>130 dB	>125 dB	>130 dB
High sensitivity ¹⁾	<-125 dBm	<-130 dBm	<-125 dBm	<-130 dBm
High measurement speed	<125 μ s/point			
Fast IEC/IEEE bus ²⁾	<15 ms			
High frequency resolution	10 μ Hz			
Short calibration times ³⁾	<20 s			
Large display	active 26 cm colour LCD			

¹⁾ With *External Measurements* option.

²⁾ From marker request to data output (real and imaginary values).

³⁾ Automatic two-port calibration with *AutoKal* option.

ZVRE and ZVCE – the economy models

The test set of these models comprises **two SWR bridges or directional couplers**, an RF switch, two measurement channels and one reference channel. They measure the magnitude and phase of all four S-parameters of a DUT, allow a full two-port calibration (TOSM) and have an exceptionally high measurement accuracy and wide dynamic range.

ZVR and ZVC – the universal models

ZVR and ZVC comprise a test set with **two SWR bridges or directional couplers**, an RF switch, two measurement channels and – unlike ZVRE and ZVCE – **two reference channels**. With this configuration a variety of novel calibration procedures (e.g. TNA) can be performed, which considerably improves the accuracy particularly with non-coaxial applications. ZVR and ZVC are the allrounders of the family and suitable for applications in R&D and production no matter how sophisticated.

Vector Network Analyzer ZVR with External Measurements option

Three times top speed

High sweep rate

The high measurement speed allows more than 25 sweeps/s with 200 points. This gives a real analog feeling for tuning sensitive DUTs in real time.



The short measurement time of $<125 \mu\text{s}$ per point considerably increases the throughput in automatic test systems.

Fast IEC/IEEE bus

Reading out a single marker value via the IEC/IEEE bus takes only 5 ms, reading out complete trace data (200 values) less than 15 ms, which considerably speeds up complex, computer-controlled measurements.

Short calibration times

With the Rohde&Schwarz calibration method *AutoKal*, a simple through-connection of the test ports is sufficient to perform automatic full two-port calibration. This calibration takes just a few seconds (including computation of correction values) and cuts time and operating errors to a minimum.

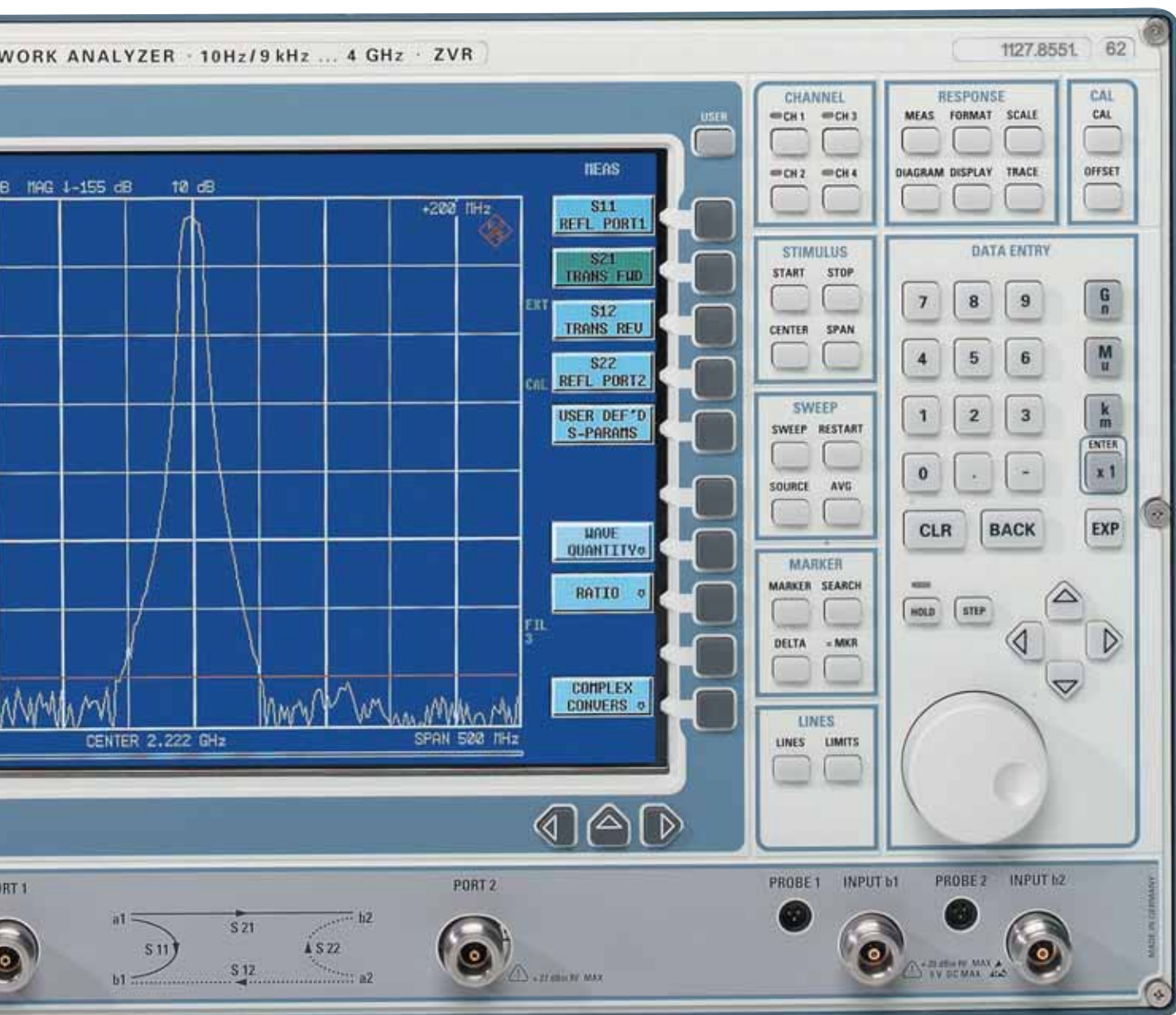

Technical details

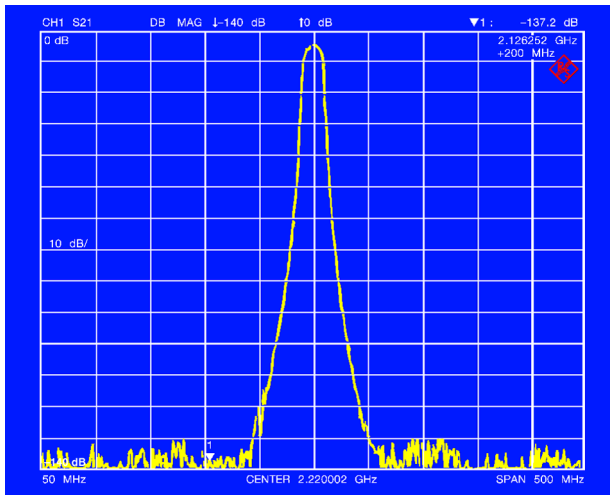

Bandpass filter

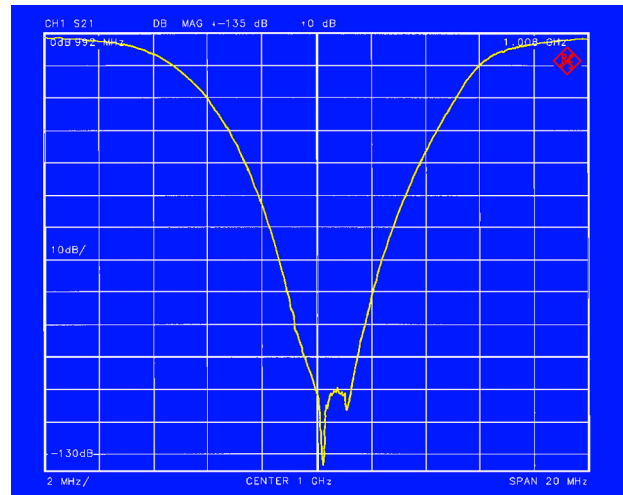

Bandstop filter

Speed >>25 sweeps/s

The extremely low-noise and fast synthesizer in conjunction with an exceptionally large measurement bandwidth of up to 26 kHz allows real-time result display. The ZVx measures not in two subsequent sweeps but at every frequency point in forward and backward direction and thus all four S-parameters – including system error correction. This ensures real-time display of fully corrected data even during alignments with reduced sweep speeds. The dynamic range of ZVx is more than 95 dB even at a high measurement rate of 25 sweeps/s and 10 kHz measurement bandwidth.

Dynamic range >130 dB

The high stopband and low passband attenuation of modern RF components place new demands on network analyzers. Thanks to fundamental mixing, the useful dynamic range of Rohde & Schwarz network analyzers is more than 25 dB better than with conventional sampling techniques. Because of the low-noise front end, Rohde & Schwarz network analyzers attain a

dynamic range of >130 dB, so transmission measurements on DUTs with extremely high stopband attenuation can be performed with high accuracy, even at low input levels.

Power calibration: testing active DUTs

Power calibration performed in the factory enables constant output power and high accuracy in the measurement of absolute input level over the full frequency range. This is particularly important for frequency-converting measurements and non-linear measurements on active components. Furthermore, frequency-dependent level variations of an external test setup can be measured and compensated with the aid of the *Power Calibration* option.

Simultaneous display of four traces on the 26 cm colour LCD

The ZVx models are the first network analyzers in this price class to simultaneously display up to four measurement traces with independent parameters (measured quantity, frequency range,

bandwidth, etc). The large, active colour LCD with high refresh rate allows precise alignments without operator fatigue.

Internal PC

The network analyzers are equipped with a PC board including interfaces for keyboard, mouse, printer, external monitor and WindowsNT as the operating system. In the PC mode, the internal hard disk can be accessed and PC programs executed on the ZVR. This function considerably simplifies operation, processing and result recording. The optional Ethernet link, the integration of any printer driver and the execution of IEC/IEEE bus control programs on ZVR considerably extend the application range and performance.

Complete setups, traces, numerical results, limit lines, calibration data, macros and screenshots can be stored on the hard disk or on floppy disks. The available formats (e.g. WMF, ASCII, Serenade™) allow problem-free import to Windows programs. The data can be processed in the ZVR with the aid of the internal PC.

Two-port calibration procedures	Number of calibration steps	Special features
TOM	5	Implicit verification
TRM	5	Especially for test fixtures
TRL	4	High directivity
TNA	3	Especially for planar circuits
TOSM	7	Classic procedure
TOM-X	5 (9)	Eliminates crosstalk

Overview of full two-port calibration procedures

		Number of test points		
		51	201	401
IEC/IEEE-bus data transfer of real and imaginary values Time between sending the request and availability of data				
ASCII		40 ms	90 ms	160 ms
IEEE-754 floating-point format Setting data 64 bit, measurement data 32 bit		10 ms	15 ms	25 ms
Measurement times (fast mode)				
Normalized unidirectional incl. retrace time, 5 ms		15 ms	30 ms	60 ms
Two-port calibr. bidirectional		20 ms	60 ms	100 ms

Measurement and IEC/IEEE-bus speed of network analyzers

Automatic test systems

Fast recording and processing of measured data and, in addition, an SCPI-conformal IEC/IEEE bus command set make all models of the ZVR family ideal for use in automatic measurement systems. All models are equipped with two IEC/IEEE bus interfaces as standard. One is used for analyzer control via an external PC, the other for controlling external devices, e.g. signal sources for intermodulation or mixer measurements, from the ZVR. Another optional IEC/IEEE bus interface is provided for the internal PC. Via this interface, IEC/IEEE control programs can be executed on the internal PC, thus enabling the ZVR to control itself or complete test systems. The *Ethernet* option allows data exchange and control via LAN.

Efficient calibration techniques

The classic 12-term calibration method requires four calibration standards: Through, Open, Short and Match. The name TOSM given to this method is an abbreviation of the standards' names. A number of other modern calibration methods (TOM, TRM, TRL, TNA) are also provided in ZVR and ZVC. Unlike TOSM (12-term) they require only three different standards. Additionally, lines (L), reflecting one-ports with unknown reflection coefficient (R), matched attenuators (A) and two-port networks (N) with symmetrical reflection can be used. Due to its simplicity, TOM is the method recommended for general applications. For calibration at frequencies up to 100 MHz it is not even necessary to connect an open circuit, and the ports may simply be left open. Thus a complete two-port calibration can be performed with only two calibration standards. TOM allows also implicit verification so that errors caused by defective calibration kits or operating errors are excluded. This considerably enhances reliability in the laboratory and particularly in production.

With on-wafer measurements, measurements on PCBs or in fixtures it is difficult to design or specify suitable calibration standards at justifiable effort. This problem can be solved with the TNA and TRM calibration methods developed and patented by Rohde & Schwarz. With these methods the characteristics of the calibration standards need not be fully known. With TNA, for instance, a full two-port calibration can be performed with two standards: if reflection symmetry is provided at the reference planes, the calibration step with network (N) does not require a standard to be connected, the test ports can just be let open. Just a through (T) with known length and a matched attenuator (A) are required.

The calibration effort is reduced to a minimum when the *AutoKal* option is used that requires only one simple through-connection.

Applications

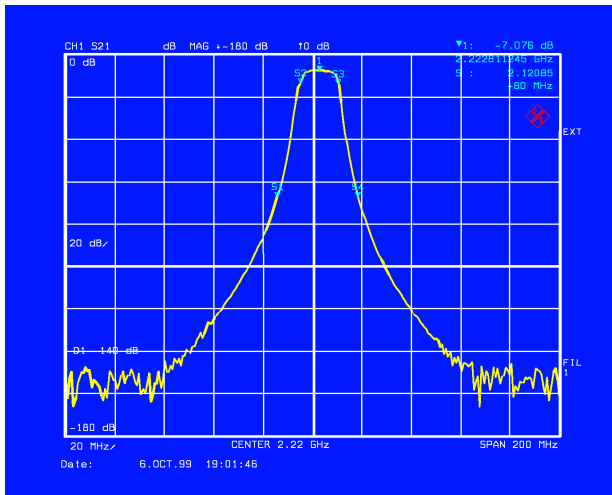

1

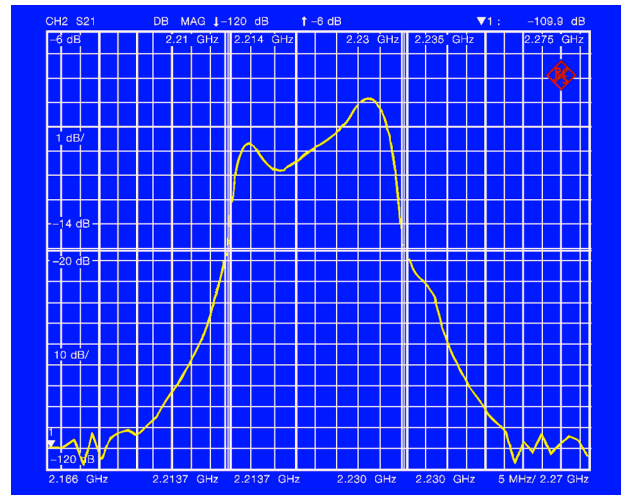

2

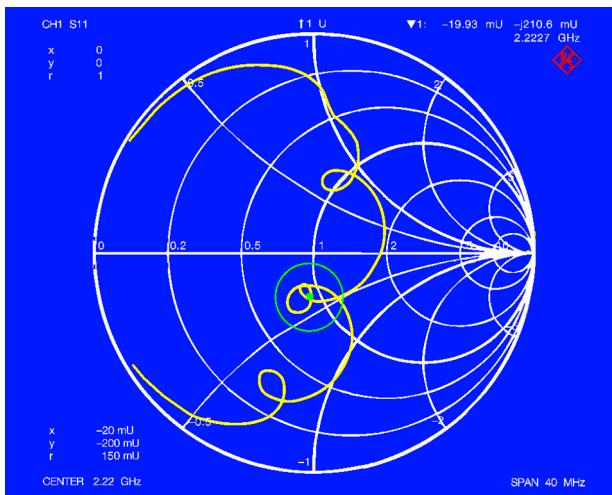

3

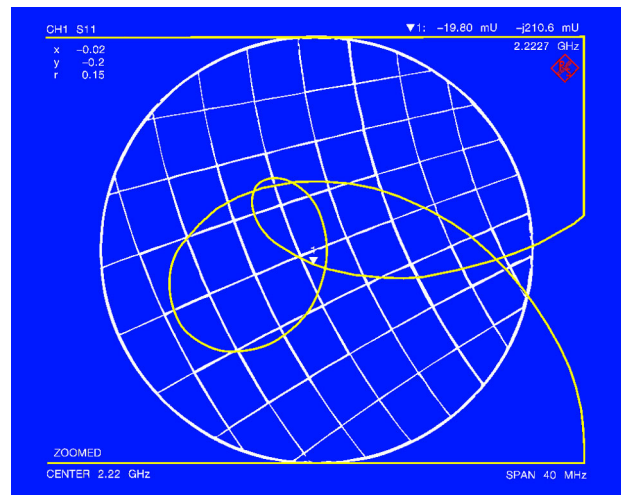

4

Filter measurements (1 to 4)

Accurate transmission and reflection measurements on narrowband DUTs such as resonators and filters require a stable generator with high frequency resolution, a receiver with wide dynamic range, and high measurement speed. The analyzers of the ZVR family are ideal for such measurements.

Special band-filter evaluation functions (1) minimize the time required for checking and tuning filters. Important filter data such as bandwidth, center frequency, Q and shape factor are displayed at a keystroke. Marker tracking functions provide updated

information on amplitude and frequency in real time during DUT adjustment. User-defined frequency and scale segments (2) simplify and speed up evaluation of selected subranges of a sweep.

Fully arbitrary zoom even in the Smith chart allows the user to concentrate on selected parts of the trace (3 and 4).

Mixers and amplifiers (5, 6)

For measuring active components featuring high gain and high isolation, a wide dynamic range as well as high sensitivity and isolation of measurement channels are required. In addition

to S-parameters and derived quantities, nonlinear parameters can also be measured:

- magnitude of 2nd, 3rd and of higher order harmonics
- n dB compression point
- IP_2 and IP_3

These parameters can also be displayed versus frequency.

Due to the use of two independent synthesizers for the generator and receiver and the ability to control two external generators, a variety of measurements can be performed at maximum speed and dynamic range on frequency-converting DUTs, e.g. mixers (5).

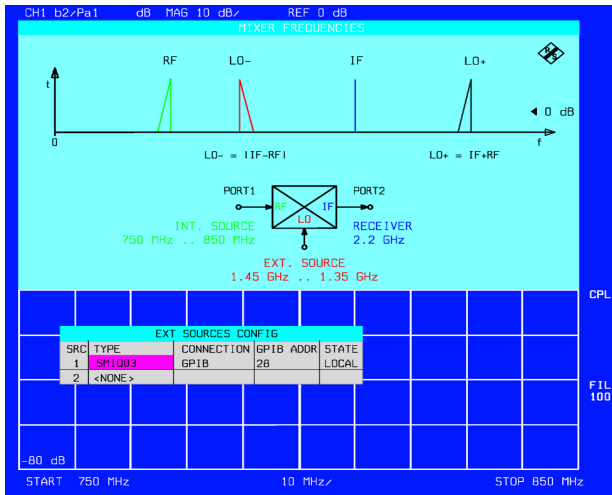

5

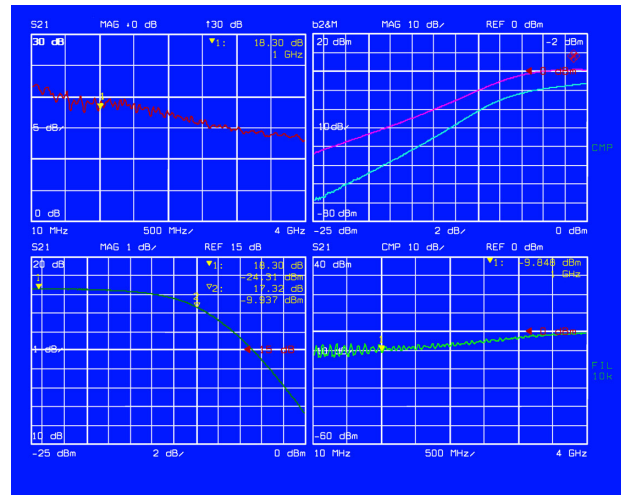

6

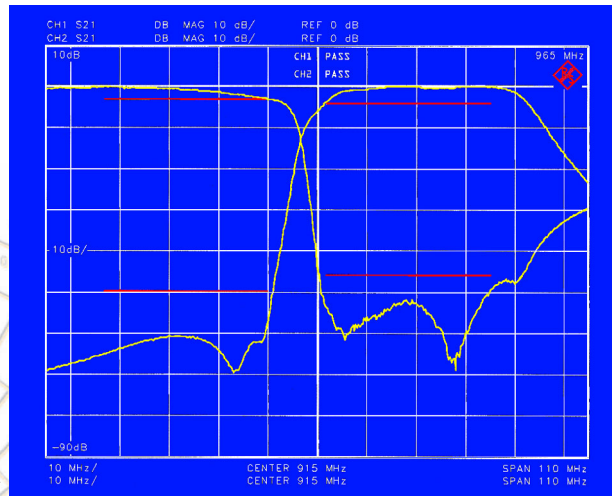

7

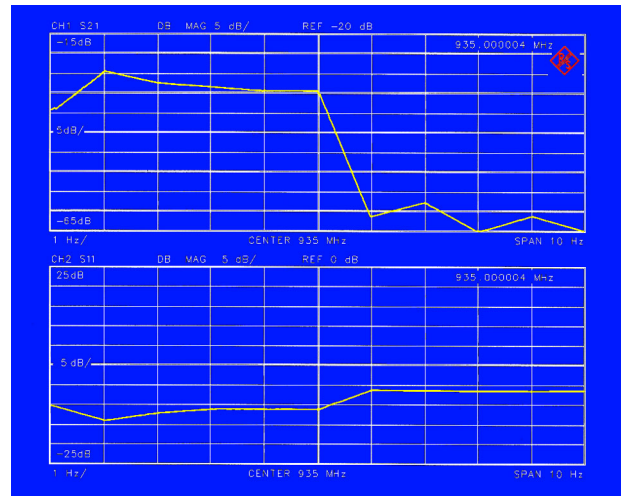

8

Thanks to the special receiver concept employed by Rohde&Schwarz analyzers, additional components such as filters are not required for the suppression of spurious.

The decoupling of all four display channels allows to set up different measurement parameters like calibration, number of points or measurement mode for each display, e.g. during amplifier measurements. This permits simultaneous display of gain and harmonics versus frequency and power as well as of the 1 dB compression point versus frequency (6).

Compatible with CAE tools

When developing circuits on the computer with the aid of CAE tools, it is essential for the S-parameters measured on a DUT to be transferred to the respective CAE program. Measured S-parameters are stored on floppy disk in a CAE-tool-compatible format and ready for processing by simulation programs. Conversely, data from simulation programs can be used in an S-parameter measurement. A typical application is the simulation of matching networks in SAW filter measurements. The *Virtual Embedding Networks* option makes it possible to simulate networks – e.g. matching networks – theoretically by combining

their S-parameter values with the measurement result (embedding) or to correct for physical networks (de-embedding).

Measurements on duplex filters (7)

Duplex filters, which are widely used in mobile radio, need simultaneous measurement and adjustment on several signal paths in real time. With the aid of the *3-Port* and *4-Port Adapter* options, several passband characteristics, e.g. of the TX and RX path, can be displayed quasi-simultaneously. All measurement paths can be calibrated independently.

System configuration



Measurements on pulsed signals (8)

In the field of mobile radio it is important to know the transient response of an amplifier under operating conditions. The high measurement speed and comprehensive trigger capabilities allow the measurement of magnitude and phase of S-parameters and intermodulation products even during a GSM burst.

Configurations

- **ZVRE**
bidirectional with three receiver channels, 9 kHz to 4 GHz
- **ZVCE**
bidirectional with three receiver channels, 20 kHz to 8 GHz
- **ZVR**
bidirectional with four receiver channels, 9 kHz to 4 GHz
- **ZVC**
bidirectional with four receiver channels, 20 kHz to 8 GHz

By using four instead of three receiver channels, ZVR and ZVC unlike ZVRE and ZVCE provide additional powerful calibration methods such as TOM, TRL, TRM, TNA and the 15-term method TOM-X (X = crosstalk), e.g. for on-wafer measurements.

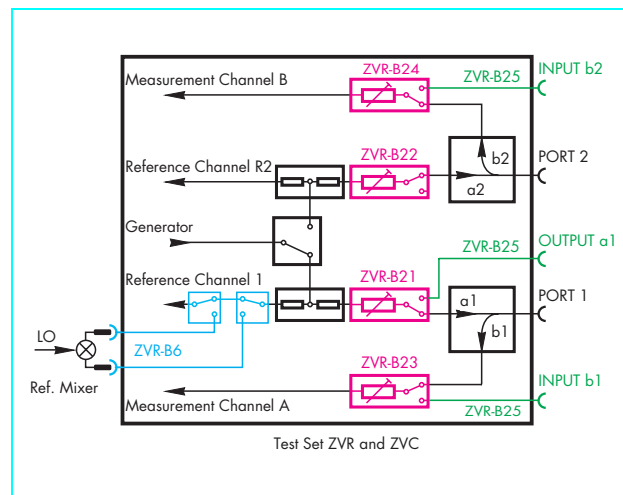
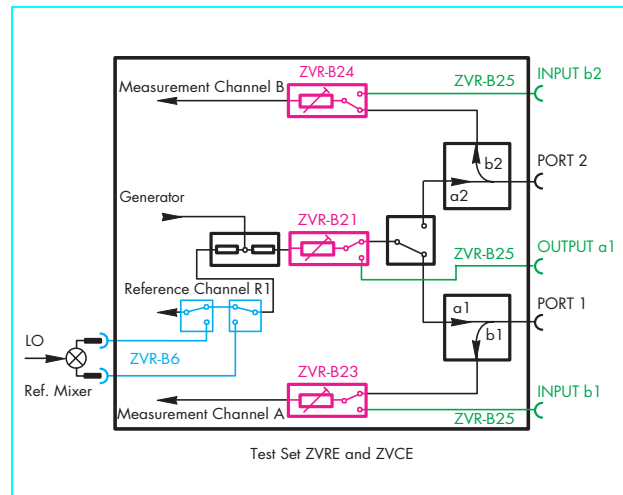

Test sets

The network analyzers can be provided with different test set options so that an optimally configured test setup can be made available to suit the applications.

Depending on the model, the test sets comprise one or two power splitters, an electronic switch and one or two SWR bridges or directional couplers. Additional step attenuators (0 dB to 70 dB) can be inserted into the generator paths and the two measurement channels to extend the power range of the receivers to +27 dBm and to generate very low levels of down to -95 dBm.

The test set of analyzers up to 4 GHz comprises SWR bridges only and is available with a characteristic impedance of 50 Ω or 75 Ω . A 50 Ω test set is standard equipment.

Because the RF characteristics of SWR bridges and couplers are different, the 8 GHz instruments ZVC and ZVCE are offered either with bridges or couplers. It depends on the application whether the bridge or the coupler model should be used. The model with SWR bridges should be chosen for measurements on frequency-converting DUTs such as mixers or active devices such as amplifiers below 1 GHz because of the better port match. Since the test set with couplers is superior regarding the dynamic range and output level it

Accessories



Test cables and calibration kit (type N)



Air lines (type N) and calibration kit (PC 3.5)

should be preferred for measurements on mixers and amplifiers above 1 GHz as well as on passive devices.

Test sets containing SWR bridges are available as active or passive model, test sets with couplers come only as 50 Ω active versions. When an active test set is used, the DUT can be powered directly via the inner conductor of the port (port bias).

When the test sets comprise attenuators and the *External Measurements* option, generator and receiver can be directly switched to three additional ports on the front panel (OUTPUT a1, INPUT b1, INPUT b2) by bypassing the bridges or couplers. This increases output power, sensitivity and dynamic range. In addition, measurements down to 10 Hz can be performed with the 4 GHz models. The test ports are fitted with female N connectors.

Test cables and adapters

DUTs are connected to the analyzers via flexible, highly phase-stable cables with precision connectors. This ensures excellent reproducibility of measurements. To obtain optimum port match Rohde & Schwarz offers precision cables with N and/or PC 3.5 connectors that match the connectors of the analyzer.

Calibration kits

The accuracy of a calibrated network analyzer is determined by the quality of the calibration standard and the reproducibility of connections.

Rohde & Schwarz offers calibration kits for all common connector types for the calibration of network analyzers.

To obtain maximum measurement accuracy, every calibration kit is individually specified. The characteristic data of the standards are supplied on a floppy disk.

The calibration kits include the required standards for TOSM (12-term) and TOM calibration. A kit contains the standards with male and female connectors. Sliding matches are also available. Supplementary calibration kits for the TRL and TOM-X methods can also be supplied.

The T-Check method developed by Rohde & Schwarz serves for fast and simple accuracy checks as an alternative to the verification of the measurement accuracy in a calibrated network analyzer system.

Specifications

Unless otherwise stated, specifications apply to test ports PORT1 and PORT2, a nominal source power of -10 dBm at the port and an IF bandwidth ≤10 kHz.

The arrow marks important data.

Measurement range

Frequency range

Without External Measurements option

ZVRE, ZVR

with passive SWR bridges

50 Ω or 75 Ω

9 kHz to 4 GHz

with active SWR bridges

50 Ω or 75 Ω

300 kHz to 4 GHz

ZVCE, ZVC

with passive SWR bridges, 50 Ω

with active SWR bridges, 50 Ω

with active couplers, 50 Ω

20 kHz to 8 GHz

300 kHz to 8 GHz

20 kHz to 8 GHz

With External Measurements option

ZVRE, ZVR

ZVCE, ZVC

10 Hz to 4 GHz

20 kHz to 8 GHz

Frequency uncertainty

Resolution

$4 \times 10^{-6} + 1 \times 10^{-6}/a$

10 μHz

Measurement speed (above 2 MHz)

Number of points

Measurement time per point

1 to 2001 (selectable)

IF bandwidth (IFBW)

3 kHz

10 kHz

26 kHz

with system error correction

normalized

in fast mode

with system error correction

normalized

<1080 μs <480 μs <360 μs

<540 μs <240 μs <210 μs

- - <240 μs

- - <125 μs

Dynamic range (without system error correction)

(The dynamic range is defined as the difference between the maximum source power and the peak value displayed after smoothing the measured trace for the transmission magnitude with an aperture of 1%, which is caused by inherent noise and crosstalk with test ports short-circuited.)

ZVRE, ZVR

(ZVRE: at IF bandwidth 10 Hz values are reduced by 5 dB)

With passive SWR bridges, 50 Ω

20 kHz to 200 kHz

IF bandwidth

10 Hz

3 kHz

10 kHz

>65 dB, - -

typ. >110 dB

200 kHz to 20 MHz

20 MHz to 3 GHz

3 GHz to 4 GHz

>110 dB >90 dB >85 dB

>120 dB >100 dB >95 dB

>110 dB >90 dB >85 dB

With active SWR bridges, 50 Ω

300 kHz to 1 MHz

1 MHz to 20 MHz

20 MHz to 3 GHz

3 GHz to 4 GHz

>107 dB >87 dB >82 dB

>110 dB >90 dB >85 dB

>120 dB >100 dB >95 dB

>110 dB >90 dB >85 dB

With passive SWR bridges, 75 Ω

20 kHz to 200 kHz

200 kHz to 20 MHz

20 MHz to 4 GHz

>50 dB, - -

typ. >95 dB

>95 dB >75 dB >70 dB

>105 dB >85 dB >80 dB

With active SWR bridges, 75 Ω

300 kHz to 1 MHz

1 MHz to 20 MHz

20 MHz to 4 GHz

>95 dB >75 dB >70 dB

>105 dB >85 dB >80 dB

>102 dB >80 dB >75 dB

With External Measurements option

50 Hz to 200 kHz

200 kHz to 20 MHz

20 MHz to 1 GHz

1 GHz to 3 GHz

3 GHz to 4 GHz

>75 dB - -

>110 dB >95 dB >90 dB

>130 dB >110 dB >105 dB

>120 dB >100 dB >95 dB

>110 dB >95 dB >90 dB

ZVCE, ZVC

(model ZVCE: at IF bandwidth 10 Hz values are reduced by 5 dB)

With passive SWR bridges, 50 Ω

20 kHz to 200 kHz

200 kHz to 20 MHz

20 MHz to 3 GHz

3 GHz to 4 GHz

4 GHz to 6 GHz

6 GHz to 8 GHz

With active SWR bridges, 50 Ω

300 kHz to 20 MHz

20 MHz to 3 GHz

3 GHz to 4 GHz

4 GHz to 6 GHz

6 GHz to 8 GHz

With active couplers, 50 Ω

20 kHz to 200 kHz

200 kHz to 20 MHz

20 MHz to 3 GHz

3 GHz to 4 GHz

4 GHz to 6 GHz

6 GHz to 8 GHz

With External Measurements option

20 kHz to 200 kHz

200 kHz to 20 MHz

20 MHz to 1 GHz

1 GHz to 3 GHz

3 GHz to 4 GHz

4 GHz to 6 GHz

6 GHz to 8 GHz

IF bandwidth

10 Hz

3 kHz

10 kHz

>50 dB, - -

typ. >80 dB

>90 dB >70 dB >65 dB

>110 dB >90 dB >85 dB

>100 dB >80 dB >75 dB

>95 dB >75 dB >65 dB

>95 dB >75 dB >70 dB

>115 dB >95 dB >90 dB

>105 dB >85 dB >80 dB

>100 dB >80 dB >75 dB

>95 dB >75 dB >70 dB

>60 dB, - -

typ. >90 dB

>100 dB >80 dB >75 dB

>120 dB >100 dB >95 dB

>110 dB >90 dB >85 dB

>105 dB >85 dB >80 dB

>100 dB >80 dB >75 dB

>75 dB - -

>110 dB >95 dB >90 dB

>130 dB >110 dB >105 dB

>120 dB >100 dB >95 dB

>110 dB >95 dB >90 dB

>105 dB >90 dB >85 dB

>100 dB >85 dB >80 dB

Crosstalk between measurement channels with total reflection at test ports (values for 75 Ω models and ZVC/E models with SWR bridges are 6 dB higher)

ZVRL, ZVRE, ZVCE

ZVR, ZVC

20 kHz to 200 kHz

200 kHz to 5 MHz

5 MHz to 1 GHz

1 GHz to 3 GHz

3 GHz to 4 GHz

4 GHz to 6 GHz (ZVCE, ZVC)

6 GHz to 8 GHz (ZVCE, ZVC)

<-90 dB, typ. <-110 dB

<-120 dB

<-125 dB <-130 dB

<-115 dB <-120 dB

<-105 dB <-110 dB

<-100 dB <-105 dB

<-95 dB <-100 dB

Stability of measurement trace at 0 dB

per degree temperature variation

ZVRE, ZVR

ZVCE, ZVC

<0.05 dB or 0.4°

<0.1 dB or 1°

Measurement bandwidth

(IF bandwidth IFBW)

1 Hz to 10 kHz (half-decade steps)

and 26 kHz (full)

Measurement accuracy

These data are valid between 20°C and 30°C, provided the instrument has reached thermal equilibrium (about 1 h after switch-on) and the temperature variation is not more than 1 degree after calibration.

ZVRE and ZVR (bidirectional network analyzers)

Accuracy of transmission measurements

after full two-port system error correction (TOSM)

Specifications are based on a matched DUT and refer to a nominal source power of -10 dBm at the test port.

Test set 50 Ω (active or passive SWR bridges available)

20 kHz to 300 kHz (passive SWR bridges only)

at 10 Hz IF bandwidth

for +10 dB to +3 dB

for +3 dB to -20 dB (typ. -55 dB)

for -20 dB to -30 dB (typ. -65 dB)

for -30 dB to -45 dB (typ. -80 dB)

<1 dB or 6°

<0.2 dB or 2°

<0.5 dB or 4°

<1 dB or 6°

300 kHz to 4 GHz

at 10 Hz IF bandwidth	
for +10 dB to +3 dB	<1 dB or 6°
for +3 dB to -5 dB	<0.2 dB or 1°
for -5 dB to -60 dB (passive)	<0.05 dB or 0.4° ¹⁾
for -5 dB to -60 dB (active)	<0.2 dB or 1°
for +3 dB to -40 dB	typ. <0.025 dB
for -60 dB to -70 dB	<0.2 dB or 1°
for -70 dB to -80 dB (ZVRE)	<1 dB or 6°
for -70 dB to -85 dB (ZVR)	<1 dB or 6°
at 3 kHz IF bandwidth	
for +10 dB to +3 dB	<1 dB or 6°
for +3 dB to -5 dB	<0.2 dB or 1°
for -5 dB to -40 dB (passive)	<0.05 dB or 0.4° ¹⁾
for -5 dB to -40 dB (active)	<0.2 dB or 1°
for -40 dB to -50 dB	<0.2 dB or 1°
for -50 dB to -60 dB (ZVRE)	<1 dB or 6°
for -50 dB to -65 dB (ZVR)	<1 dB or 6°
at 10 kHz IF bandwidth	
for +10 dB to +3 dB	<1 dB or 6°
for +3 dB to -5 dB	<0.2 dB or 1°
for -5 dB to -35 dB (passive)	<0.05 dB or 0.4° ¹⁾
for -5 dB to -35 dB (active)	<0.2 dB or 1°
for -35 dB to -45 dB	<0.2 dB or 1°
for -45 dB to -55 dB (ZVRE)	<1 dB or 6°
for -45 dB to -60 dB (ZVR)	<1 dB or 6°

Test set 75 Ω (active or passive SWR bridges available)

20 kHz to 300 kHz (passive SWR bridges only)

at 10 Hz IF bandwidth	
for +10 dB to +3 dB	<1 dB or 6°
for +3 dB to -5 dB (typ. -40 dB)	<0.2 dB or 2°
for -5 dB to -15 dB (typ. -50 dB)	<0.5 dB or 4°
for -15 dB to -30 dB (typ. -65 dB)	<1 dB or 6°

300 kHz to 4 GHz

at 10 Hz IF bandwidth	
for +10 dB to +3 dB	<1 dB or 6°
for +3 dB to -5 dB	<0.2 dB or 1°
for -5 dB to -45 dB (passive)	<0.05 dB or 0.4° ¹⁾
for -5 dB to -45 dB (active)	<0.2 dB or 1°
for -45 dB to -55 dB	<0.2 dB or 1°
for -55 dB to -65 dB (ZVRE)	<1 dB or 6°
for -55 dB to -70 dB (ZVR)	<1 dB or 6°
at 3 kHz IF bandwidth	
for +10 dB to +3 dB	<1 dB or 6°
for +3 dB to -5 dB	<0.2 dB or 1°
for -5 dB to -25 dB (passive)	<0.05 dB or 0.4° ¹⁾
for -5 dB to -25 dB (active)	<0.2 dB or 1°
for -25 dB to -35 dB	<0.2 dB or 1°
for -35 dB to -45 dB (ZVRE)	<1 dB or 6°
for -35 dB to -50 dB (ZVR)	<1 dB or 6°
at 10 kHz IF bandwidth	
for +10 dB to +3 dB	<1 dB or 6°
for +3 dB to -5 dB	<0.2 dB or 1°
for -5 dB to -20 dB (passive)	<0.05 dB or 0.4° ¹⁾
for -5 dB to -20 dB (active)	<0.2 dB or 1°
for -20 dB to -30 dB	<0.2 dB or 1°
for -30 dB to -40 dB (ZVRE)	<1 dB or 6°
for -30 dB to -45 dB (ZVR)	<1 dB or 6°

ZVRE and ZVR – Accuracy of reflection measurements

after system error correction (TOSM or full one-port)

Specifications are based on an isolating DUT and refer to a nominal source power of -10 dBm at the test port.

Test set 50 Ω (active or passive SWR bridges available)

It is assumed that the return loss of match used for calibration is >46 dB (effective system data: directivity $D_{\text{eff}} > 46$ dB, test port match $S_{\text{eff}} > 30$ dB).

20 kHz to 4 GHz (passive SWR bridges),

300 kHz to 4 GHz (active SWR bridges)

for +10 dB to +3 dB	<1 dB or 6°
for +3 dB to -15 dB	<0.4 dB + 0.04 dB-f/GHz, <3° + 0.4°-f/GHz
for -15 dB to -25 dB	<1 dB or 6°
for -25 dB to -35 dB	<3 dB or 20°

Test set 75 Ω (active or passive SWR bridges available)

It is assumed that the return loss of the match used for calibration is >40 dB (effective system data: directivity $D_{\text{eff}} > 40$ dB, test port match $S_{\text{eff}} > 26$ dB).

20 kHz to 4 GHz (passive SWR bridges),

300 kHz to 4 GHz (active SWR bridges)

for +10 dB to +3 dB	<1.5 dB or 10°
for +3 dB to -10 dB	<0.7 dB + 0.04 dB-f/GHz, <5° + 0.4°-f/GHz
for -10 dB to -20 dB	<1 dB or 6°
for -20 dB to -30 dB	<3 dB or 20°

ZVCE and ZVC (bidirectional network analyzers)

Accuracy of transmission measurements

after full two-port system error correction (TOSM)

Analyzers with SWR bridges

Specifications are based on a matched DUT and refer to a nominal source power of -10 dBm at the test port.

300 kHz to 4 GHz

at 10 Hz IF bandwidth	
for +3 dB to -60 dB	<0.2 dB or 1°
for +3 dB to -40 dB	typ. <0.025 dB
for -60 dB to -70 dB	<0.2 dB or 1°
for -70 dB to -80 dB (ZVCE)	<1 dB or 6°
for -70 dB to -85 dB (ZVC)	<1 dB or 6°
at 3 kHz IF bandwidth	
for +3 dB to -40 dB	<0.2 dB or 1°
for -40 dB to -50 dB	<0.2 dB or 1°
for -50 dB to -55 dB (ZVCE)	<1 dB or 6°
for -50 dB to -60 dB (ZVC)	<1 dB or 6°
at 10 kHz IF bandwidth	
for +3 dB to -35 dB	<0.2 dB or 1°
for -35 dB to -45 dB	<0.5 dB or 4°
for -45 dB to -55 dB (ZVCE)	<1 dB or 6°
for -45 dB to -60 dB (ZVC)	<1 dB or 6°

4 GHz to 8 GHz

at 10 Hz IF bandwidth	
for +3 dB to -35 dB	<0.2 dB or 2°
for +3 dB to -30 dB	typ. <0.025 dB
for -35 dB to -45 dB (ZVCE)	<1 dB or 6°
for -35 dB to -50 dB (ZVC)	<1 dB or 6°
at 3 kHz IF bandwidth	
for +3 dB to -15 dB	<0.2 dB or 2°
for -15 dB to -20 dB (ZVCE)	<1 dB or 6°
for -15 dB to -25 dB (ZVC)	<1 dB or 6°
at 10 kHz IF bandwidth	
for +3 dB to -10 dB	<0.2 dB or 2°
for -10 dB to -15 dB (ZVCE)	<1 dB or 6°
for -10 dB to -20 dB (ZVC)	<1 dB or 6°

Analyzers with couplers

Specifications are based on a matched DUT and refer to a nominal source power of -20 dBm at the test port.

20 kHz to 10 MHz

at 10 Hz IF bandwidth	
for +10 dB to +3 dB	<1 dB or 6°
for +3 dB to -20 dB (typ. -55 dB)	<0.2 dB or 2°
for -20 dB to -30 dB (typ. -65 dB)	<0.5 dB or 4°
for -30 dB to -45 dB (typ. -80 dB)	<1 dB or 6°

10 MHz to 4 GHz

at 10 Hz IF bandwidth	
for +10 dB to +3 dB	<1 dB or 6°
for +3 dB to -50 dB	<0.2 dB or 1°
for +3 dB to -40 dB	typ. <0.025 dB
for -50 dB to -60 dB	<0.5 dB or 4°
for -60 dB to -70 dB (ZVCE)	<1 dB or 6°
for -60 dB to -75 dB (ZVC)	<1 dB or 6°
at 3 kHz IF bandwidth	
for +10 dB to +3 dB	<1 dB or 6°
for +3 dB to -30 dB	<0.2 dB or 1°
for -30 dB to -40 dB	<0.5 dB or 4°
for -40 dB to -45 dB (ZVCE)	<1 dB or 6°
for -40 dB to -50 dB (ZVC)	<1 dB or 6°

¹⁾ <0.1 dB or <1° for 300 kHz to 1 MHz.

at 10 kHz IF bandwidth	
for +10 dB to +3 dB	<1 dB or 6°
for +3 dB to -25 dB	<0.2 dB or 1°
for -25 dB to -35 dB	<0.5 dB or 4°
for -35 dB to -45 dB (ZVCE)	<1 dB or 6°
for -35 dB to -50 dB (ZVC)	<1 dB or 6°

4 GHz to 8 GHz

at 10 Hz IF bandwidth	
for +10 dB to +3 dB	<1 dB or 6°
for +3 dB to -45 dB	<0.2 dB or 2°
for +3 dB to -40 dB	typ. <0.025 dB
for -45 dB to -55 dB (ZVCE)	<1 dB or 6°
for -45 dB to -60 dB (ZVC)	<1 dB or 6°
at 3 kHz IF bandwidth	
for +10 dB to +3 dB	<1 dB or 6°
for +3 dB to -25 dB	<0.2 dB or 2°
for -25 dB to -30 dB (ZVCE)	<1 dB or 6°
for -25 dB to -35 dB (ZVC)	<1 dB or 6°
at 10 kHz IF bandwidth	
for +10 dB to +3 dB	<1 dB or 6°
for +3 dB to -20 dB	<0.2 dB or 2°
for -20 dB to -25 dB (ZVCE)	<1 dB or 6°
for -20 dB to -30 dB (ZVC)	<1 dB or 6°

ZVCE and ZVC – Accuracy of reflection measurements

after system error correction (TOSM or full one-port)

It is assumed that the return loss of the match used for calibration is >40 dB (effective system data: directivity D_{eff} >40 dB, test port match S_{eff} >30 dB).

Analyzers with SWR bridges

Specifications are based on an isolating DUT and refer to a nominal source power of -10 dBm at the test port.

300 kHz to 8 GHz

for +3 dB to -10 dB	<0.4 dB + 0.04 dB·f/GHz, <3° + 0.4°·f/GHz
for -10 dB to -20 dB	<1 dB or 6°
for -20 dB to -30 dB	<3 dB or 20°

Analyzers with couplers

Specifications are based on an isolating DUT and refer to a nominal source power of -20 dBm at the test port.

20 kHz to 8 GHz

for +10 dB to +3 dB	<1 dB or 6°
for +3 dB to -10 dB	<0.4 dB + 0.04 dB·f/GHz, <3° + 0.4°·f/GHz
for -10 dB to -20 dB	<1 dB or 6°
for -20 dB to -30 dB	<3 dB or 20°

Effective system data (above 200 kHz)

These data are valid between 20°C and 30°C, provided the instrument has reached thermal equilibrium (about 1 h after switch-on) and the temperature variation is not more than 1 degree after calibration.

ZVRE, ZVR, ZVCE, ZVC

(bidirectional network analyzers)

after full two-port system error correction (TOSM)

	ZVRE, ZVR 50 Ω	75 Ω	ZVCE, ZVC 50 Ω
Directivity	>46 dB ¹⁾	>40 dB ²⁾	>40 dB ²⁾
Source match	>40 dB ³⁾	>36 dB ⁴⁾	>36 dB ⁴⁾
Load match	>46 dB ¹⁾	>40 dB ²⁾	>40 dB ²⁾
Transmission tracking	<0.04 dB	<0.06 dB	<0.06 dB
Reflection tracking	<0.04 dB	<0.06 dB	<0.06 dB

¹⁾ Return loss of match >46 dB.

²⁾ Return loss of match >40 dB.

³⁾ Phase deviation of open standard <1°.

⁴⁾ Phase deviation of open standard <1.6°.

Output power

Power range (without options)

ZVRE, ZVR with test set 50 Ω	-25 dBm to 0 dBm
ZVRE, ZVR with test set 75 Ω	-27 dBm to -6 dBm
ZVCE, ZVC with SWR bridges	
300 kHz to 6 GHz	-25 dBm to -5 dBm
6 GHz to 8 GHz	-25 dBm to -8 dBm
ZVCE, ZVC with couplers	
20 kHz to 6 GHz	-25 dBm to 0 dBm
6 GHz to 8 GHz	-25 dBm to -3 dBm

Uncertainty (at -10 dBm)

These data are valid between 20°C and 30°C.

up to 2 MHz	<1 dB
above 2 MHz	<0.5 dB

Linearity above 40 kHz (referred to -10 dBm)

These data are valid between 20°C and 30°C.

0 dBm to -15 dBm	<0.4 dB
-15 dBm to -25 dBm (ZVR/E/L)	<0.6 dB
-15 dBm to -25 dBm (ZVC/E)	<0.8 dB

Resolution 0.1 dB

Spectral purity

	ZVRE, ZVR	ZVCE, ZVC
Harmonics		
At maximum source power		
40 kHz to 70 MHz	<-22 dBc	<-25 dBc
70 MHz to 400 MHz	<-25 dBc	<-25 dBc
above 400 MHz	<-30 dBc	<-25 dBc
At -10 dBm source power		
up to 600 MHz	<-35 dBc	<-35 dBc
above 600 MHz	<-40 dBc	<-35 dBc

Spurious

<-40 dBc

SSB phase noise

1 Hz bandwidth, 10 kHz from carrier

up to 10 MHz	<-110 dBc
10 MHz to 150 MHz	<-100 dBc
150 MHz to 1 GHz	<-90 dBc
above 1 GHz	<-90 dBc + 20·log(f/GHz)

(<-78 dBc at 4 GHz,
<-72 dBc at 8 GHz)

Residual FM

RMS weighting from 10 Hz to 3 kHz

up to 10 MHz	<1 Hz
10 MHz to 150 MHz	<2 Hz
150 MHz to 1 GHz	<5 Hz
1 GHz to 2 GHz	<10 Hz
2 GHz to 4 GHz	<20 Hz
above 4 GHz	<40 Hz

Input level

Maximum nominal input level	Receiver step attenuator	
	0 dB	≥30 dB
Without options	0 dBm	-
With Receiver Step Attenuator option	0 dBm	+27 dBm

Damage level

Without options	+27 dBm	-
With Receiver Step Attenuator option	+27 dBm	+30 dBm

Damage DC current/voltage

With passive test set	
(internal DC short $R_{\text{in}} < 0.1 \Omega$)	0.5 A
With active test set	0.5 A or 30 V

RMS noise level (50 Ω, without options)

With 75 Ω models and the ZVC/E models with SWR bridges the noise level is higher by 6 dB.

Frequency range	IF bandwidth	Noise level
9 kHz to 50 kHz	1 kHz	<-75 dBm
50 kHz to 200 kHz	3 kHz	<-70 dBm
200 kHz to 20 MHz	3 kHz	<-90 dBm
20 MHz to 3 GHz	3 kHz	<-100 dBm
3 GHz to 4 GHz	3 kHz	<-90 dBm
4 GHz to 8 GHz	3 kHz	<-80 dBm

Test sets

In contrast to passive test sets, active test sets allow a direct DC bias of an (active) DUT via the inner conductor of the test ports.

Impedance	ZVRE, ZVR ZVCE, ZVC	50 Ω or 75 Ω 50 Ω
-----------	------------------------	----------------------

Match ZVRE, ZVR

(without system error correction)

Passive SWR bridges, 50 Ω	
40 kHz to 100 kHz	>10 dB
100 kHz to 100 MHz	>16 dB
100 MHz to 3 GHz	>18 dB
3 GHz to 4 GHz	>16 dB
Active SWR bridges, 50 Ω	
300 kHz to 1 MHz	>6 dB
1 MHz to 100 MHz	>16 dB
100 MHz to 3 GHz	>18 dB
3 GHz to 4 GHz	>16 dB
Passive SWR bridges, 75 Ω	
40 kHz to 100 kHz	>6 dB
100 kHz to 100 MHz	>12 dB
100 MHz to 3 GHz	>18 dB
3 GHz to 4 GHz	>15 dB
Active SWR bridges, 75 Ω	
300 kHz to 1 MHz	>4 dB
1 MHz to 100 MHz	>12 dB
100 MHz to 3 GHz	>18 dB
3 GHz to 4 GHz	>10 dB

Match ZVCE, ZVC

(without system error correction)

Passive SWR bridges, 50 Ω	
40 kHz to 10 MHz	>10 dB
10 MHz to 100 MHz	>16 dB
100 MHz to 3 GHz	>18 dB
3 GHz to 4 GHz	>16 dB
4 GHz to 8 GHz	>6 dB
Active SWR bridges, 50 Ω	
300 kHz to 5 MHz	>6 dB
5 MHz to 100 MHz	>16 dB
100 MHz to 3 GHz	>18 dB
3 GHz to 4 GHz	>16 dB
4 GHz to 8 GHz	>6 dB
Active couplers, 50 Ω	
20 kHz to 1 GHz	>6 dB
1 GHz to 8 GHz	>10 dB

PORT 2 (without system error correction) >18 dB

System error correction techniques

All analyzer models offer simple normalizations for reflection and transmission measurements, one-path two-port calibration and a full one-port calibration (3-term). Full two-port calibration TOSM (12-term) can be carried out with models ZVRE and ZVCE. ZVR and ZVC offer the greatest variety of modern system error correction methods. Apart from the techniques already mentioned, the following full two-port procedures are available: TOM, TRM, TRL, TNA, TOM-X (15-term). The names indicate the standards used for calibration:

T = Through

The T standard is a two-port standard which establishes a direct low-loss connection between the two test ports. A frequency-dependent attenuation can also be taken into account by the analyzer. The standard has to be well matched and may have any electrical length, which has to be exactly known (compare L standard).

O = Open

The O standard is a one-port standard. It realizes total reflection with a magnitude of one in the ideal case and a phase of approx. 0°. The phase response versus frequency must be accurately known to the analyzer (coefficients C_i). A frequency-dependent increase of the return loss can be considered by the analyzer. The electrical length of the O standard may be different from zero and must be exactly known.

S = Short

The S standard is a one-port standard. It realizes total reflection with a magnitude of one in the ideal case and a phase of approx. 180° at short-circuit plane (coefficients L_i). A frequency-dependent increase of the return loss can be considered by the analyzer. The electrical length of the S standard may differ from zero and must be known. It causes a length-proportional frequency dependence of the phase.

M = Match

The M standard is a one-port standard which in the ideal case realizes a zero-reflection termination for the reference impedance (mostly 50 Ω). A sliding match is often used at high frequencies because it yields higher effective directivities than fixed loads.

R = Reflect

The R standard is a one-port standard. In contrast to the M standard it features high reflection which may assume any unknown value. It must be known however whether the reflect approaches an open or a short-circuit. Since line transformation must be expected because of the electrical length of the R standard, the electrical length has to be approximately known.

L = Line

The L standard is a two-port standard. It establishes an almost perfectly matched connection between the two test ports and defines the reference impedance. A frequency-dependent attenuation caused by the L standard can be considered by the analyzer. The L standard must have an electrical length that differs from that of the T standard, but the difference should not amount to an integer multiple of half the wavelength (singularity).

N = Network

The N standard is a two-port standard featuring symmetrical reflection which may assume any value other than zero but has to be identical at both ports. Same as with the R standard it must be known whether the reflection approaches an open or a short-circuit. Transmission of the N standard is arbitrary, need not be known and may vary arbitrarily versus frequency. In the extreme case it may even be one or zero.

A = Attenuator

The A standard is a two-port standard. It has to be well matched and may feature any unknown loss different to that of the T standard.

TOM-X (X = crosstalk) is an extension of the TOM method. It considers all possible crosstalk between the four receiver channels (full model). Since this technique does not use approximations, it is particularly effective in the elimination of crosstalk and thus in increasing the effective dynamic range of the system. This method however needs a higher effort. Alternatively, the automatic calibration procedure *AutoKal* (Rohde & Schwarz patent) is available as an option for ZVRE, ZVR, ZVCE and ZVC.

Display

Screen	26 cm colour LCD
Resolution	640 x 480 x 256
Sweep modes	frequency, power and time
Parameter formats (examples)	S parameters and derived quantities like SWR, impedance, admittance, group delay, etc, as well as nonlinear parameters (optional) like n dB compression point, SOL and TOI. Complex parameters are displayed either in a complex form or formatted to magnitude, phase, real or imaginary part
Diagrams (examples)	Cartesian: linear, simple or double logarithmic, segmented polar: linear, logarithmic or segmented Smith (any zoom), Inverted Smith, Charter
Scale (examples)	0.001 dB/to 50 dB/ 10 m°/to 200 k°/ 1 pU/to 10 kU/
MAX/MIN scale	automatically variable number of grid lines
Multichannel display	up to 4 independent display channels (CH1 to CH4)

Screen formats (examples)	overlay, dual or quad-channel split
Markers	8 normal markers or 7 delta markers for each display channel
Marker resolution	4 significant digits
Marker formatting	selectable, independent of trace formatting
Automatic marker functions	marker tracking, marker search, marker target, bandfilter functions, (Q, shape factor, etc)
Trace mathematics	all four arithmetical operations with up to three operands
Display lines	horizontal lines, circles or radial lines
Limit lines	pairs of curves formed from line segments in Cartesian diagrams, any circles in polar diagrams

Inputs/outputs (basic unit)

Probe power connector (PROBE 1 and PROBE 2)	
Operating voltages	+15 V ± 0.3 V (<300 mA), -12 V ± 0.6 V (<300 mA)
EXT TRIGGER	
(input for external trigger signal)	edge-triggered TTL signal
Polarity (selectable)	positive or negative
Minimum pulse width	1 µs
LEVEL (input for external level control)	
Frequency range	0 Hz to 100 kHz
Voltage range	0 V to 10 V
Input impedance	>10 kΩ
EXT FREQ REF IN (input for external reference frequency)	
Frequency	1 MHz to 15 MHz in 1 MHz steps
Max. permissible deviation	6×10^{-6}
Input level (V_{rms})	0.1 V to 3 V
Input impedance	1 kΩ
EXT FREQ REF OUT (output for internal reference frequency)	
Frequency	10 MHz
Inaccuracy	$<4 \times 10^{-6} + 1 \times 10^{-6}/a$
Level (sine)	12 dBm ± 3 dB into 50 Ω
ANALYZER MONITOR	
	IBM-PC-compatible VGA connector for analyzer
PC MONITOR	
	IBM-PC-compatible VGA connector
MOUSE	
	IBM-PC-compatible PS/2 connector
KEYBOARD	
	IBM-PC-compatible 5-contact DIN connector
USER (input/output)	
	16 bits, TTL, user-programmable, 25-contact sub-D
COM 1/COM 2	
	IBM-PC-compatible serial interfaces
IEC BUS/IEC SYSTEM BUS	
	RS-232-C, 9-contact sub-D remote-control interfaces, IEEE 488, IEC-625-1, 24 contacts
LPT	
	IBM-PC-compatible printer interface, Centronics, 25-contact sub-D
MULTIPOINT	
	control of optional three-port and four-port adapters
DC MEAS INPUTS	
	Voltage range -10 V to +10 V
	Measurement accuracy 0.1 V
	Input resistance >10 kΩ

Optional inputs/outputs (rear panel)

PORT BIAS1/2 (inputs) DC bias for PORT1/2 (for active test sets only)	<200 mA or <30 V
---	------------------

Mixer Measurements option EXTERNAL GENERATOR

Connectors for high-speed control of an external generator from Rohde&Schwarz families SME/SMP. The BLANK signal is low at each frequency point of the sweep and high during the transition from one point to the next. The analyzer controls the external generator by means of the TRIGGER signal. To set the generator to the next frequency point, the TRIGGER signal goes high for a brief period of time.

BLANK (input)	TTL signal
TRIGGER (output)	TTL signal

Reference Channel Ports option a1 EXT OUT and a1 EXT IN

SMA connector pair to connect an external reference mixer for measurements on frequency-converting DUTs.

Other optional interfaces

(e.g. LAN Ethernet) are available and will be specified on request.

Specifications of options

External Measurements option

This option adds three additional front-panel connectors, OUTPUT a1, INPUT b1 and INPUT b2, to the basic unit (ZVRL: PORT 2 is used as INPUT b2) to provide direct access to the generator output and the two receiver inputs. Internal SWR bridges or couplers are bypassed. As a result, frequency range (with ZVRL, ZVRE and ZVR towards the lower end), output power and sensitivity of the network analyzer increase.

	ZVRE, ZVR	ZVCE, ZVC
Frequency range	10 Hz to 4 GHz	20 kHz to 8 GHz
Characteristic impedance	50 Ω	50 Ω
Output power at OUTPUT a1	-85 dBm to +7 dBm	-85 to +3 dBm
Power uncertainty (at -10 dBm)		
These data are valid between 20°C and 30°C.		
up to 2 MHz	<1 dB	<1 dB
above 2 MHz	<0.5 dB	<0.5 dB
Power linearity (referred to -10 dBm)		
These data are valid between 20°C and 30°C.		
+7 dBm to 0 dBm	<0.4 dB	-
0 dBm to -7 dBm	<0.4 dB	<0.4 dB
-7 dBm to -15 dBm	<0.6 dB	<0.4 dB
-15 dBm to -20 dBm	-	<0.6 dB
Parasitic DC at OUTPUT a1		
up to 10 MHz		<100 mV
above 10 MHz		<20 mV
Match of INPUT b1 and INPUT b2		>8 dB
	Receiver step attenuator	
	0 dB	≥30 dB
Maximum nominal input level at INPUT b1 and INPUT b2	-3 dBm	+27 dBm
Damage level at INPUT b1 and INPUT b2	+20 dBm	+30 dBm
Max. nominal DC	5 V	
Damage DC	5 V	

RMS noise level (with step attenuators set to 0 dB)
(For models ZVCE and ZVC values are reduced by 5 dB.)

Frequency range	IF bandwidth	Noise level
10 Hz to 50 Hz (ZVRL, ZVRE, ZVR)	1 Hz	<-115 dBm
50 Hz to 500 Hz (ZVRL, ZVRE, ZVR)	10 Hz	<-105 dBm
500 Hz to 20 kHz (ZVRL, ZVRE, ZVR)	100 Hz	<-95 dBm
20 kHz to 50 kHz	1 kHz	<-85 dBm
50 kHz to 200 kHz	3 kHz	<-80 dBm
200 kHz to 20 MHz	3 kHz	<-100 dBm
20 MHz to 3 GHz	3 kHz	<-110 dBm
3 GHz to 4 GHz	3 kHz	<-100 dBm
4 GHz to 8 GHz (ZVCE, ZVC)	3 kHz	<-90 dBm

Dynamic range see table on page 10

Generator/Receiver Step Attenuator PORT 1/2 options

These options permit the level of the output/input signals at PORT 1/2 to be attenuated in 10 dB steps between 0 dB and 70 dB.

Frequency range	same as analyzer
Attenuation	0 dB to 70 dB
Attenuation steps	10 dB
Attenuation uncertainty	<2 dB

Power Calibration option

With this firmware option the analyzer power can be calibrated precisely. The source power (additional power meter e.g. NRVD, NRVS or NRV from Rohde&Schwarz required) as well as the absolute power measurement of the receiver input signals (including a 1 EXT) can be calibrated.

AutoKal option

The AutoKal module is used for automatic analyzer calibration and employs a patented calibration method. It is connected to PORT 1 and PORT 2 of the network analyzer and remains connected during all calibrations and measurements. It is, therefore, an integral part of the analyzer system and its two type N jacks are used as PORT 1 and PORT 2. The DUT can be connected to these ports directly or via a test cable.

Frequency range	0 Hz to 8 GHz
Impedance	50 Ω
Operating temperature range	+5°C to +40°C

Time Domain option

Display and gating of measured values in the time domain and transformation back to the frequency domain.

3-Port Adapter option

This option adds a third port to the two ports of the network analyzer. The option contains an electronic switch for connecting PORT 1 of the analyzer alternatively to PORT 1 or PORT 3 of the 3-Port Adapter. PORT 2 of the analyzer is directly connected to PORT 2 of the option and is not switched.

Frequency range	9 kHz to 4 GHz
Impedance	50 Ω
Match ¹⁾	

(3-Port Adapter only)

at PORT 1 and PORT 3	>13 dB
at PORT 2	>20 dB

Attenuation¹⁾

PORT 1 and PORT 3	
Through-connected	<6 dB
Blocked (up to 1 MHz)	>90 dB
Blocked (above 1 MHz)	>100 dB
PORT 2	<0.5 dB

4-Port Adapter option

This option adds two further ports to the two ports of the network analyzer. It comes in two models (02 and 03), which provide different switching functions and are thus particularly suitable for specific 4-port DUTs.

Model 02 comprises two separate switches (SPDT). The first connects PORT 1 of the analyzer alternately to PORT 1 or PORT 3 of the 4-Port Adapter. The second connects PORT 2 of the network analyzer alternately to PORT 2 or PORT 4 of the 4-Port Adapter.

Model 03 connects PORT 1 of the network analyzer directly to PORT 1 of the 4-Port Adapter while PORT 2 of the analyzer can be switched to one of the remaining three ports of the 4-Port Adapter.

Frequency range	9 kHz to 4 GHz
Impedance	50 Ω

Match¹⁾ (4-Port Adapter only)

Model 02	>13 dB
Model 03 (up to 100 MHz)	>9 dB
Model 03 (above 100 MHz)	>13 dB

Attenuation¹⁾

Through-connected	
Model 02	<6 dB
Model 03	<12 dB
Blocked (up to 1 MHz)	>90 dB
Blocked (above 1 MHz)	>100 dB

Virtual Embedding Networks option

This option allows measured networks or simulated networks from a CAD program to be considered in the measurement results. Mismatched DUTs such as SAW filters can be matched virtually without any additional hardware being required. Furthermore, the effect of real embedding networks like test fixtures can be eliminated by calculation complementary to calibration procedures.

Increased Output Power for Port 1 option

This option increases the output power at PORT 1 and OUTPUT a1. The maximum power depends on the instrument model.

Max. nominal output power

	PORT 1	OUTPUT a1
ZVRE, ZVR	+13 dBm	+20 dBm
ZVCE, ZVC with SWR bridges		
20 kHz to 2 GHz	+6 dBm	+13 dBm
2 GHz to 6 GHz	+4 dBm	+11 dBm
6 GHz to 8 GHz	+1 dBm	+11 dBm
ZVCE, ZVC with couplers		
20 kHz to 2 GHz	+10 dBm	+13 dBm
2 GHz to 6 GHz	+8 dBm	+11 dBm
6 GHz to 8 GHz	+5 dBm	+11 dBm

Power variation (without Generator Step Attenuator PORT 1 option)

ZVRE, ZVR	-25 dB
ZVCE, ZVC with bridges	
20 kHz to 6 GHz	-23 dB
6 GHz to 8 GHz	-20 dB
ZVCE, ZVC with couplers	
20 kHz to 6 GHz	-25 dB
6 GHz to 8 GHz	-22 dB

Power linearity

These data are valid between 20°C and 30°C.

ZVRE, ZVR (referred to +3 dBm)	
9 kHz to 40 kHz	< 1 dB
40 kHz to 4 GHz	+13 dBm to -2 dBm < 0.4 dB
	-2 dBm to -12 dBm < 0.6 dB
ZVCE, ZVC with bridges (referred to 0 dBm)	
20 kHz to 6 GHz	+6 dBm to -9 dBm < 0.4 dB
	-9 dBm to -17 dBm < 0.6 dB
6 GHz to 8 GHz	+3 dBm to -9 dBm < 0.4 dB
	-9 dBm to -17 dBm < 0.6 dB
ZVCE, ZVC with couplers (referred to 0 dBm)	
20 kHz to 6 GHz	+10 dBm to -5 dBm < 0.4 dB
	-5 dBm to -15 dBm < 0.6 dB
6 GHz to 8 GHz	+7 dBm to -5 dBm < 0.4 dB
	-5 dBm to -15 dBm < 0.6 dB

Power uncertainty

These data are valid between 20°C and 30°C.

(power +3 dBm with ZVRE, ZVR, 0 dBm with ZVCE, ZVC)	
up to 2 MHz	< 1 dB
above 2 MHz	< 0.5 dB

Harmonics

At max. output power		
20 kHz to 40 GHz	-20 dBc	
40 kHz to 70 MHz	-22 dBc	
70 MHz to 2 GHz	-25 dBc	
2 GHz to 4 GHz	-20 dBc	
4 GHz to 8 GHz (ZVCE, ZVC)	-20 dBc	
	ZVRL, ZVRE, ZVR	ZVCE, ZVC
At output power	+3 dBm	0 dBm
20 kHz to 20 MHz	-30 dBc	-30 dBc
20 MHz to 2 GHz	-35 dBc	-35 dBc
2 GHz to 4 GHz	-35 dBc	-32 dBc
4 GHz to 8 GHz (ZVCE, ZVC)		-32 dBc

Linearity for ratios (b1/a1 and b2/a1) versus source power

ZVRE, ZVR	
(referred to +3 dBm)	< 0.1 dB
ZVCE, ZVC	
(referred to 0 dBm)	< 0.3 dB

Crosstalk in reverse direction

20 kHz to 200 kHz	<-75 dB
200 kHz to 5 MHz	<-105 dB
5 MHz to 1 GHz	<-110 dB
1 GHz to 3 GHz	<-100 dB
3 GHz to 4 GHz	<-90 dB
4 GHz to 6 GHz (ZVCE, ZVC)	<-90 dB
6 GHz to 8 GHz (ZVCE, ZVC)	<-85 dB

Mixer Measurements option

This option allows network analysis for frequency-converting DUTs (single and multiple conversion) and almost any kind of harmonics and spurious measurements to be performed.

Nonlinear Measurements option

With this option fast measurements of the n dB compression point and of second- and third-order intermodulation products (IP2, IP3, SOI, TOI) can be carried out versus frequency.

¹⁾ Raw data (without system error correction).

Reference Channel Ports option

Extends the *Mixer Measurements* option and can be used to generate a reference signal when an additional external mixer is connected to the a1 EXT connectors on the rear panel.

Ethernet option

With this option the analyzer can be networked (LAN).

IEC/IEEE Bus Interface for internal PC (optional)

This option provides a third IEC/IEEE bus interface to the internal PC in addition to the two IEC/IEEE bus interfaces provided as standard.



Ordering information

Order designation	Type	Frequency range	Order No.
Vector Network Analyzers (test sets included)*			
3-channel, bidirectional, 50 Ω, passive	ZVRE	9 kHz to 4 GHz	1127.8551.51
3-channel, bidirectional, 50 Ω, active	ZVRE	300 kHz to 4 GHz	1127.8551.52
4-channel, bidirectional, 50 Ω, passive	ZVR	9 kHz to 4 GHz	1127.8551.61
4-channel, bidirectional, 50 Ω, active	ZVR	300 kHz to 4 GHz	1127.8551.62
3-channel, bidirectional, 50 Ω, active, couplers	ZVCE	20 kHz to 8 GHz	1127.8600.50
3-channel, bidirectional, 50 Ω, passive, SWR bridges	ZVCE	20 kHz to 8 GHz	1127.8600.51
3-channel, bidirectional, 50 Ω, active, SWR bridges	ZVCE	300 kHz to 8 GHz	1127.8600.52
4-channel, bidirectional, 50 Ω, active, couplers	ZVC	20 kHz to 8 GHz	1127.8600.60
4-channel, bidirectional, 50 Ω, passive, SWR bridges	ZVC	20 kHz to 8 GHz	1127.8600.61
4-channel, bidirectional, 50 Ω, active, SWR bridges	ZVC	300 kHz to 8 GHz	1127.8600.62
Alternative test sets*			
75 Ω Bridge Pairs for ZVRE and ZVR (instead of bridge pairs, 50 Ω)¹⁾			
75 Ω, passive	ZVR-A75	9 kHz to 4 GHz	1043.7755.28
75 Ω, active	ZVR-A76	300 kHz to 4 GHz	1043.7755.29
Options			
AutoKal	ZVR-B1	0 Hz to 8 GHz	1044.0625.02
Time Domain	ZVR-B2	–	1044.1009.02
Mixer Measurements ²⁾	ZVR-B4	–	1044.1215.02
Nonlinear Measurements	ZVR-B5	–	1044.1321.02
Reference Channel Ports	ZVR-B6	–	1044.1415.02
Power Calibration ³⁾	ZVR-B7	–	1044.1544.02
3-Port Adapter	ZVR-B8	0 Hz to 4 GHz	1086.0000.02
Virtual Embedding Networks	ZVR-K9	–	1106.8830.02
Increased Output Power for Port1 for ZVR ⁴⁾	ZVR-B10	same as analyzer	1106.6495.02
Increased Output Power for Port1 for ZVRE ⁴⁾	ZVR-B10	same as analyzer	1106.6495.03
Increased Output Power for Port1 for ZVC ⁴⁾	ZVR-B10	same as analyzer	1106.6495.04
Increased Output Power for Port1 for ZVCE ⁴⁾	ZVR-B10	same as analyzer	1106.6495.05
4-Port Adapter (2 x SPDT)	ZVR-B14	0 Hz to 4 GHz	1106.7510.02
4-Port Adapter (SP3T)	ZVR-B14	0 Hz to 4 GHz	1106.7510.03
Ethernet RJ 45 for Internal PC	FSE-B16	–	1073.5973.04
IEC/IEEE Bus Interface for Internal PC	FSE-B17	–	1066.4017.02
Generator Step Attenuator PORT 1	ZVR-B21	same as analyzer	1044.0025.11
Generator Step Attenuator PORT 2 ⁵⁾	ZVR-B22	same as analyzer	1044.0025.21
Receiver Step Attenuator PORT 1	ZVR-B23	same as analyzer	1044.0025.12
Receiver Step Attenuator PORT 2	ZVR-B24	same as analyzer	1044.0025.22
External Measurements, 50 Ω ⁶⁾	ZVR-B25	10 Hz to 4 GHz (ZVR/E) 20 kHz to 8 GHz (ZVC/E)	1044.0460.02
Service Kit ⁷⁾	ZVR-Z1	–	1044.1650.02

* **Note:** active test sets, in contrast to passive test sets, comprise internal bias networks, e.g. to supply active DUTs like amplifiers.

Order designation	Type	Frequency range	Order No.
Extras			
Test Cables (pairs)			
N (m), 50 Ω	ZV-Z11	0 Hz to 18 GHz	1085.6505.03
N (m), 75 Ω	ZV-Z12	0 Hz to 4 GHz	1085.6570.02
3.5 mm (m), N (m), 50 Ω	ZV-Z13	0 Hz to 18 GHz	1134.3997.02
3.5 mm (f), 3.5 mm (m), 50 Ω	ZV-Z14	0 Hz to 26.5 GHz	1134.4093.02
Calibration Kits			
N, 50 Ω	ZV-Z21	0 Hz to 18 GHz	1085.7099.02
N, 50 Ω	ZCAN	0 Hz to 3 GHz	0800.8515.52
N, 75 Ω	ZCAN	0 Hz to 3 GHz	0800.8515.72
PC 3.5	ZV-Z32	0 Hz to 26.5 GHz	1128.3501.02
PC 3.5 (incl. sliding matches)	ZV-Z33	0 Hz to 26.5 GHz	1128.3518.02
TRL Suppl. Kit, N, 50 Ω	ZV-Z26	0.4 to 18 GHz	1085.7318.02
TRL Suppl. Kit, PC 3.5	ZV-Z27	0.4 to 26.5 GHz	1085.7401.02
TOM-X Suppl. Kit, N, 50 Ω	ZV-Z28	0 Hz to 18 GHz	1085.7499.03
TOM-X Suppl. Kit, PC 3.5	ZV-Z29	0 Hz to 26.5 GHz	1085.7647.03
Sliding Matches			
N (m), 50 Ω	ZV-Z41	1.7 to 18 GHz	1085.8095.02
N (f), 50 Ω	ZV-Z41	1.7 to 18 GHz	1085.8095.03
PC 3.5, 50 Ω (pair m, f)	ZV-Z42	0 Hz to 26.5 GHz	1128.3524.02
Attenuators, N, 50 Ω			
1 W	DNF	0 Hz to 12.4 GHz	0272.4X10.50
50 W ⁷⁾	RBU50	0 Hz to 2 GHz	1073.8695.XX
100 W ⁷⁾	RBU100	0 Hz to 2 GHz	1073.8495.XX
Matching Pads, 50 Ω → 75 Ω			
Series resistor	RAZ	0 Hz to 2.7 GHz	0358.5714.02
L-section	RAM	0 Hz to 2.7 GHz	0358.5414.02
Accessories			
T Check	ZV-Z60	0 Hz to 4 GHz	1108.4990.50
Bias Network	ZV-Z61	2 MHz to 4 GHz	1106.8130.02
DC Block	FSE-Z3	5 MHz to 7 GHz	4010.3895.00
Power Splitter			
2 x 50 Ω	RVZ	0 Hz to 2.7 GHz	0800.6612.52
External SWR Bridges⁸⁾			
50 Ω, N (f)	ZRA	40 kHz to 150 MHz	1052.3607.52
50 Ω, N (f)	ZRB 2	5 MHz to 3 GHz	0373.9017.52
75 Ω, N (f)	ZRB 2	5 MHz to 2 GHz	0802.1018.73
50 Ω, N (f)	ZRC	40 kHz to 4 GHz	1039.9492.52
75 Ω, N (f)	ZRC	40 kHz to 2.5 GHz	1039.9492.72
Miscellaneous			
Transit Case	ZZK-965	–	1013.9437.00
19" Rack Adapter with front handles	ZZA-96	–	396.4928.00

- 1) To be ordered together with ZVR/E.
- 2) Includes harmonics measurements.
- 3) Power meter and sensor required.
- 4) ZVR-B23 and ZVR-B24 required.
- 5) Only for ZVR or ZVC (see page 8).
- 6) Attenuators required (see page 8).
- 7) On request.
- 8) Other variants available, e.g. N (m).

Options

Option	Type	ZVRE	ZVR	ZVCE	ZVC
Automatic Calibration AutoKal	ZVR-B1	■	■	■	■
Time Domain	ZVR-B2	■	■	■	■
Mixer Measurements	ZVR-B4	■	■	■	■
Nonlinear Measurements	ZVR-B5	■	■	■	■
Reference Channel Ports	ZVR-B6	■	■	■	■
Power Calibration	ZVR-B7	■	■	■	■
3-Port Adapter	ZVR-B8	■	■	■*)	■*)
Virtual Embedding Networks	ZVR-K9	–	■	–	■
Increased Output Power for Port1 or Output a1	ZVR-B10	■	■	■	■
4-Port Adapter	ZVR-B14	■	■	■*)	■*)
Ethernet for Internal PC	FSE-B16	■	■	■	■
IEC/IEEE Bus Interface for Internal PC	FSE-B17	■	■	■	■
Generator Step Attenuator PORT1	ZVR-B21	■	■	■	■
Generator Step Attenuator PORT2	ZVR-B22	–	■	–	■
Receiver Step Attenuator PORT1	ZVR-B23	■	■	■	■
Receiver Step Attenuator PORT2	ZVR-B24	■	■	■	■
External Measurements	ZVR-B25	■	■	■	■
Service Kit	ZVR-Z1	■	■	■	■
■ Available *) up to 4 GHz					

Main benefits in brief

	Features	Benefits	Model/ Option
Comprehensive measurement functions	Patented automatic two-port calibration AutoKal	Saves time, prevents operating errors	ZVR-B1
	New TOM calibration method	Only three standards needed	ZVR, ZVC
	Plausibility test during calibration	Avoids calibration errors	ZVR/E
	Power calibration	Accurate source power and receiver levels	ZVR-B7
	Independent measurement of four parameters	Combined capabilities of four analyzers	■
	Segmented diagram axes	Increased measurement speed	■
	Zoom function even in Smith diagram	Improved reading accuracy	■
	High-resolution 26 cm colour display	Clear readout, effortless operation	■
	Independent computation of markers	More information at a glance	■
	Scales with min/max values	Clear curve display	■
Versatile instrument	Nonlinear measurements	n dB compression point and intercept points directly versus frequency (IP2/IP3)	
	Universal measurements on frequency-converting DUTs	Harmonics and mixer measurements	ZVR-B4
	External reference channel ports	Group-delay measurements on frequency-converting DUTs	ZVR-B4 + ZVR-B6
	Multipoint measurements	Real-time adjustment of three-port and four-port devices	ZVR-B8, ZVR-B14
	Automatic determination of filter characteristics	Filter parameters set with a single keystroke	■
	User-defined aperture for group-delay measurements	Independent of test frequencies	■
	Triggered measurements (point/sweep)	For measuring pulsed signals	■
	Phase unwrap	Phase measurements beyond 360°	■
	Marker tracking function	Speeds up alignment	■
Automatic generation of equivalent circuit	Saves conversion of results	■	
Versatility for automatic test systems	Use of external generators	Convenient mixer and IP3 measurements	ZVR-B4
	External Measurements option	Flexible configuration of an external test set	ZVR-B25
	IEC/IEEE bus for internal PC	SCPI standard	■
	Networking capabilities/LAN	Networking with other measuring instruments and computers	FSE-B16
Links to the PC world	Use as a PC and measuring instrument	Measurement, remote control, evaluation and documentation in one unit	FSE-B 16 or FSE-B17
	Compatible to Super Compact™ and Touchstone™	Simple data exchange	■
	Four PC slots available	Configurable like a PC	■

■ Available with all models.

General data

Temperature loading	5°C to 40°C, specs complied with 0°C to 50°C, operational -40°C to 70°C, storage temp. range, meets IEC 68-2-1, IEC 68-2-2	EMC, emission	meets directives 89/336/EEC, amended by 91/263/EEC, 92/31/EEC, 93/68/EEC and EN50081-1
Damp heat	40°C at 95% rel. humidity, meets IEC 68-2-3	EMC, immunity	meets directives 89/336/EEC amended by 91/263/EEC, 92/31/EEC, 93/68/EEC and EN50082-1 to EN61010-1, UL 3111-1, CSA C22.2 No. 1010-1, IEC 1010-1
Vibration test, sinusoidal	10 Hz to 55 Hz, max. 2 g 55 Hz to 150 Hz, 0.5 g constant, 12 min/axis, meets IEC 68-2-6, IEC 1010-1, MIL-T-28800D class 5	Safety	90 V to 132 V (AC), 47 Hz to 440 Hz or 180 V to 264 V (AC), 47 Hz to 66 Hz safety class I to VDE 411
Vibration test, random	10 Hz to 300 Hz, 1.2 g rms, 5 min/axis, meets IEC 68-2-36	Power supply	max. 400 VA (standby: 10 W) VDE, GS, CSA, CSA-NRTL/C
Shock test	40 g shock spectrum, method 516.3, meets MIL-STD810D, MIL-T-28800D classes 3 and 5	Power consumption	435 mm x 281 mm x 584 mm
Calibration interval	1 year	Test mark	30 kg
		Dimensions (W x H x D)	
		Weight	

