

Optical Amplifier Analyzer AQ8423Z

Dual Band Optical Amplifier Analyzer
Switchable C-band and L-band



Dual Band Optical Amplifier Analyzer

Switchable C-band and L-band

The AQ8423Z is a unique dual-range optical amplifier analyzer. In conjunction with an external optical spectrum analyzer (OSA) and light sources (such as tunable laser sources or DFBS), the AQ8423Z can measure gain and noise figure (NF) of optical amplifiers both in C-band and L-band. Two testing wavelength ranges can be switched internally by simple operation.

The AQ8423Z employs the proven "Pulse method" technique. It utilizes 1 MHz modulation frequency, which is high enough to suppress a rise of ASE (amplified spontaneous emission) level during off signal. The AQ8423Z can achieve very high accuracy in ASE measurement resulting in accurate NF measurement.

Since the AQ8423Z can eliminate all DWDM signals simultaneously during ASE measurement, it can obtain measurement results under actual DWDM operational conditions.

Features

- **Pulse method with 1 MHz modulation**
High enough frequency to suppress a rise of ASE during a measurement
- **C- and L-band measurement capability**
Measurement range is switchable, either to C-band (1520-1580 nm) or L-band (1560-1620 nm)
- **DWDM measurement mode**
A DWDM amplifier, with multi-tone signals, can be measured under its actual operational conditions.
- **Hands-free calibration**
New hands-free calibration function, added to full user calibration feature, makes daily calibration simple and quick.
- **Maximum test channel: 200 channels**
- **Minimum channel spacing: 25 GHz**
In conjunction with AQ6317 ANDO optical spectrum analyzer

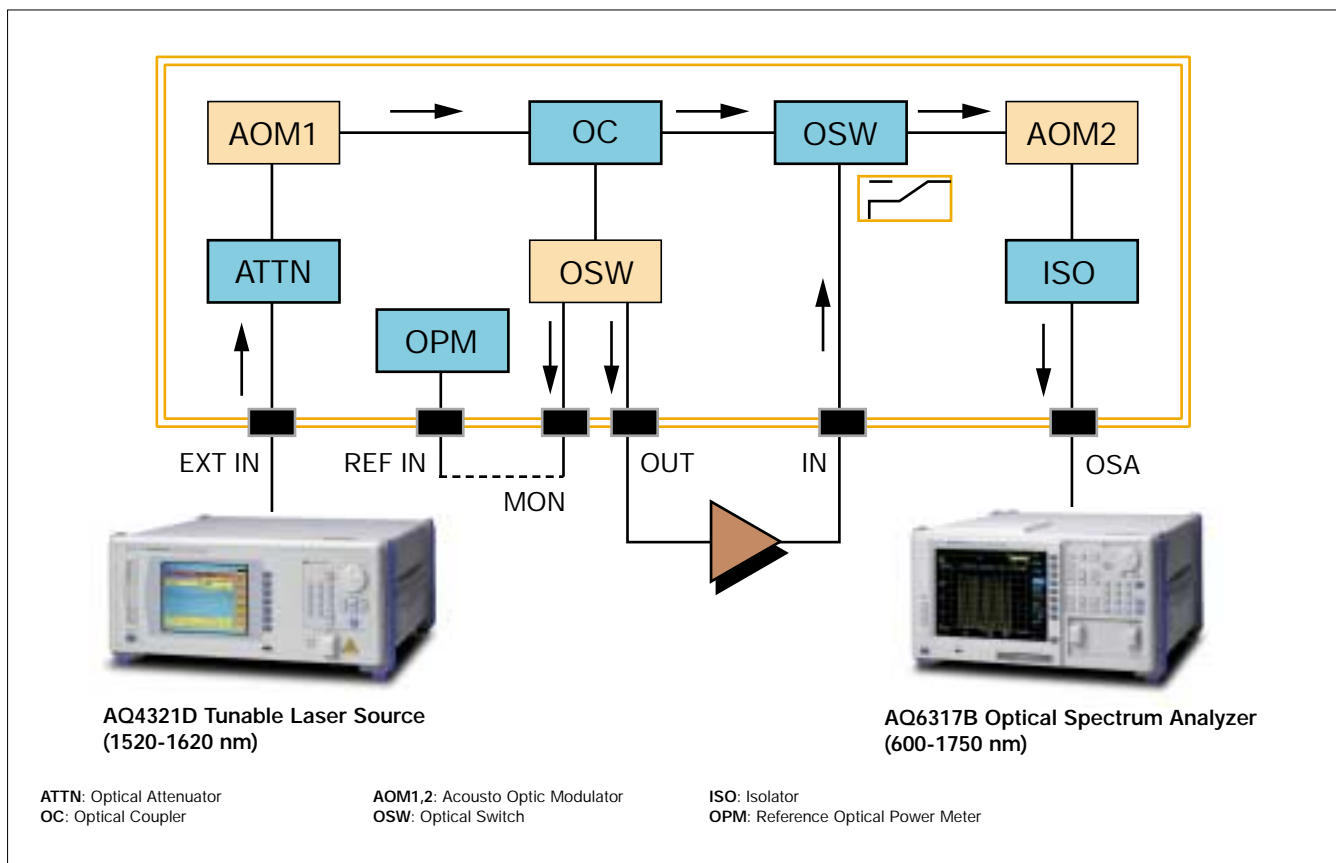



Signal and ASE detection timing

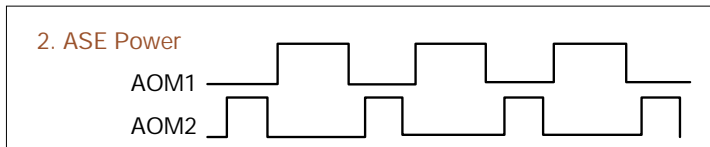
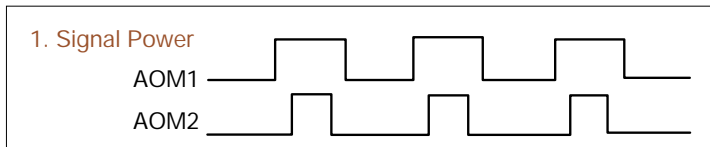

The AQ8423Z modulates signals from external light sources with AOM1, and AOM2 selects the timing to measure, signal or ASE (Amplified spontaneous emission).

When AOM2 is set for ASE measurement, AOM2 eliminates the source signal and SSE (Source spontaneous emission) without affecting the ASE level (to increase input power, a booster amplifier can be added to external light sources, the SSE includes ASE of the booster amplifier in this case). Thus, the AQ8423Z can measure the ASE at a signal wavelength very accurately.

The modulation frequency is also very important. It strongly affects ASE measurement accuracy, which results in an error on NF. In order to minimize ASE measurement errors, the AQ8423Z modulates a source signal with 1 MHz, which is high enough to suppress a rise of ASE level, to obtain high accuracy.

Effect of AOMs on optical spectrum

EDFA Output

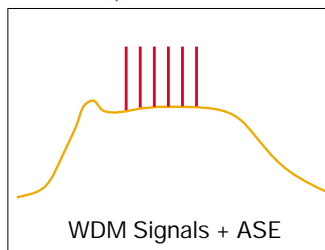

AQ8423Z Output for ASE Meas.

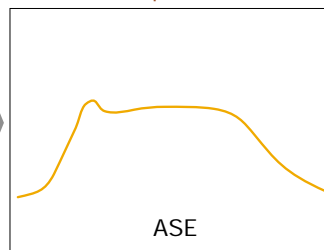

Example of measurement system configuration



Test data example

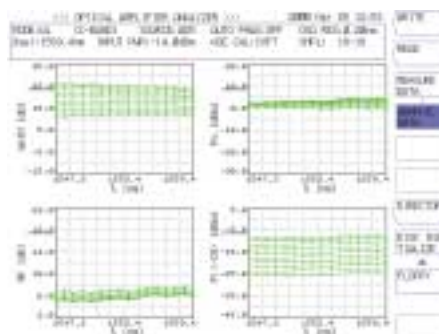

Test results displayed on AQ8423Z

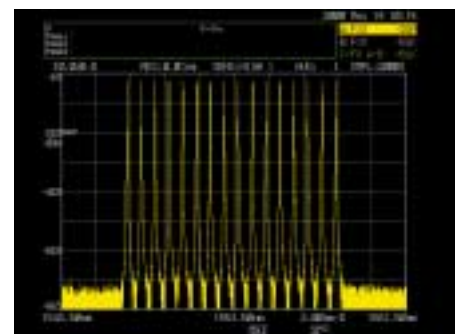

DFB-LD characteristic on AQ6317B's display

Notes

- Optical spectrum analyzer has to be ANDO product (AQ6317B is recommended).
- Optical spectrum analyzer is fully controlled by AQ8423Z via GP-IB during a measurement.
- A bunch of DFB-LDs and tunable laser source can be used as an external light source. Tunable laser source from different manufacturers can be controlled via GP-IB by AQ8423Z.

* Left picture shows a system configuration example by AQ8423Z, AQ6317B and 18-channel DFB-LD.

Specifications

| | | |
|---------------------------------------|---|---------|
| Wavelength range ¹⁾ | C-Band mode (1520 to 1580 nm) L-Band mode (1560 to 1620 nm) | |
| DUT input power range ²⁾ | -45 dBm to +10 dBm | |
| DUT output power range | +24 dBm or less | |
| Accuracy ³⁾ | Gain | ±0.2 dB |
| | NF | ±0.3 dB |
| | DUT input power | ±0.2 dB |
| | DUT output power | ±0.2 dB |
| Reproducibility ³⁾ | Gain | ±0.1 dB |
| | NF | ±0.2 dB |
| | DUT input power | ±0.1 dB |
| | DUT output power | ±0.1 dB |
| Applicable fiber | Single mode 10/125 μm | |
| Applicable optical connector | FC (SPC) | |
| Minimum channel spacing ⁴⁾ | 25 GHz | |
| Maximum channel ⁴⁾ | 200 channels | |
| Measurement time | Approx. 5 minutes (40 channels) | |
| Warm-up time | Approx. 1 hour after power on | |
| Measurement function | Wavelength dependence, input power dependence, stability | |
| Display function | Wavelength-Gain, wavelength-NF, input-output, input-Gain, input-NF, time-gain, time-NF, time-input, time-output, measurement data list, 1-, 2- and 4-waveform display | |
| Calibration function | Input power, output power, OSA effective resolution, DUT delay time | |
| Data storage | FDD (3.5-inch 2HD, 1.2/1.44MB), internal memory (for 32 waveforms) | |
| Printer | Built-in high-speed printer | |
| Interfaces | GP-IB (2-ports), video output (VGA compatible) | |
| Display | 9.4-inch color LCD | |
| Power requirements | AC100 to 120 V, AC200 to 240 V, 48 to 63 Hz, approx. 200 VA | |
| Environmental conditions | Operating temperature: 15 to 35°C Storage temperature: -10 to 50°C Humidity: 80% or less (no condensation) | |
| Dimensions and mass | Approx. 425(W) x 222(H) x 450(D) mm, approx. 20 kg | |

Notes

- 1) Either C-Band mode or L-Band mode
- 2) Maximum input power is related to the output power of light source.
- 3) ±1°C, between 15 and 35°C
- 4) In combination with AQ6317B optical spectrum analyzer



Specifications are subject to change without notice.

ANDO ELECTRIC CO., LTD.

19-7, Kamata 4-chome, Ota-ku, Tokyo, 144-0052 Japan Phone: +81(0)3 3733 1151 Fax: +81(0)3 3739 7310

ANDO CORPORATION

2021 N. Capitol Avenue, San Jose, CA 95132, U.S.A. Phone: +1 408 941 0100 Fax: +1 408 941 0103
EAST OFFICE: 7617 Standish Place, Rockville, MD 20855, U.S.A. Phone: +1 301 294 3365 Fax: +1 301 294 3359

ANDO EUROPE B.V.

"Vijverdam", Dalsteindreef 57, 1112XC Diemen, The Netherlands Phone: +31(0)20 698 1441 Fax: +31(0)20 699 8938
NIEDERLASSUNG DEUTSCHLAND: Nymphenburger Straße 119 B, D-80636 München, Germany Phone: +49(0)89 143 8150 Fax: +49(0)89 143 81555

ANDO ELECTRIC SINGAPORE PTE. LTD.

19 Kim Keat Road #05-03, Jumbo Industrial Building, Singapore 328804 Phone: +65 251 1391 Fax: +65 251 1987

Please visit our website for more information: www.ando.com